

# PIURIC

SCHWEIZER MÖBELMANUFAKTUR

GESAMTKATALOG  
CATALOGUE GÉNÉRAL  
COMPLETE CATALOGUE

# 2017





Eive

3



Softshell M + XL

9



Lenao

20



Lof

28



Slim

36



2cube

44



Lenao bett

52



SP sleeping pure

60



TX-2

66

## Eive



## Eive Lounge



## Eive Living



# Eive

Ein Möbelprogramm mit einer klaren Linie in zwei verschiedenen Sitzqualitäten.  
Durch die leichte Gestaltung, geringe Möbeltiefe und freie Wahl der Länge passt sich Eive auch begrenzten Raumsituationen problemlos an.

Sofa Sessel Sitzgruppe Ecksofa Bank Hocker

## Eive Lounge

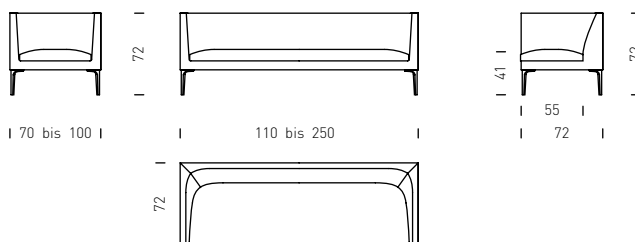

## Eive Living

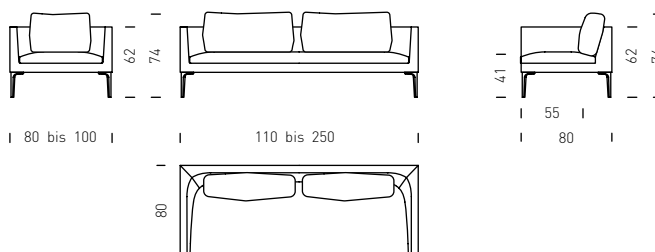

Bezug in Stoff oder Leder  
Stoffbezüge abnehmbar

Die Länge vom Möbel wird nach Mass produziert von 70/80 bis 250 cm.  
Rückenkissen werden der Länge vom Sofa und Anzahl Sitzplätzen angepasst.

Ein integrierter flacher Federleisten-Rost ermöglicht eine komfortable Sitz- und Liegequalität.

Stabile Rahmenkonstruktion aus Massivholz, Sperrholz und Stahlprofilen.

Polsteraufbau aus verschiedenen Schaumstoffen, Rückenkissen aus Daun.

Fuss aus Aluminium-Guss poliert, matt, weiss matt, schwarz matt sowie pulverbeschichtet nach RAL.

Für weitere Ausführungen, Abmessungen und Anpassung der Sitzverhältnisse kontaktieren Sie uns bitte.

## Eive

Une série de meubles avec une ligne claire en deux variations de sièges.

Grâce à son design léger, sa faible profondeur et le choix tout les longueurs de 70 à 250 cm, le modèle Eive convient à chaque pièce, même si l'espace est limité.

Sofa Fauteuil Élément d'angle Banc Tabouret

### Eive Lounge

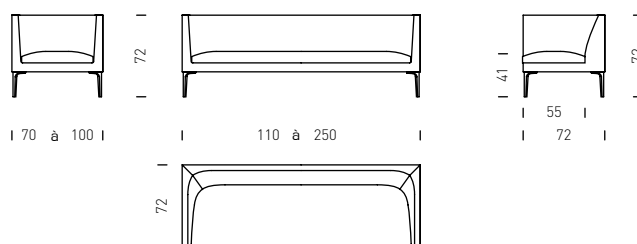

### Eive Living

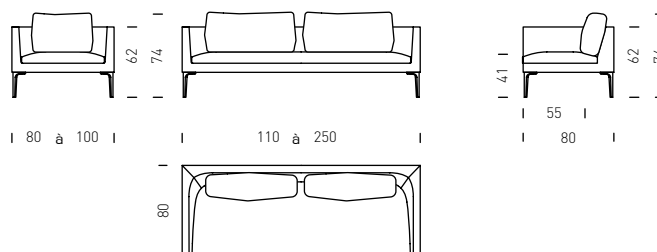

Revêtement en tissu ou cuir  
Tissu déhoussable

La longueur du meuble est disponible sur mesure de 70/80 à 250 cm. Les coussins de dos sont adaptés à la longueur du meuble et au nombre de sièges.

Un sommier à lattes ultraplat permet un grand confort, en position assise ou allongée.

Une construction à cadre stable en bois massif, bois contreplaqué et profils en acier. Rembourrage en mousses de différentes densités, Coussin de dos en plumes.

Pieds en aluminium brillant, alu mat, blanc mat, noir mat, ou RAL laqué.

Veuillez nous contacter pour d'autres dimensions, des solutions individuelles ou ajustement de la qualité d'assis.

# Eive

A furniture series with a clear line available in two different seating qualities.  
Thanks to its light design, low depth and free choice of the furniture length,  
Eive matches well where space is limited.

Sofa Armchair Corner Element Bench Stool

## Eive Lounge

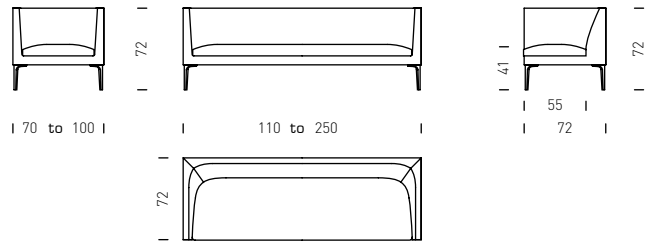

## Eive Living

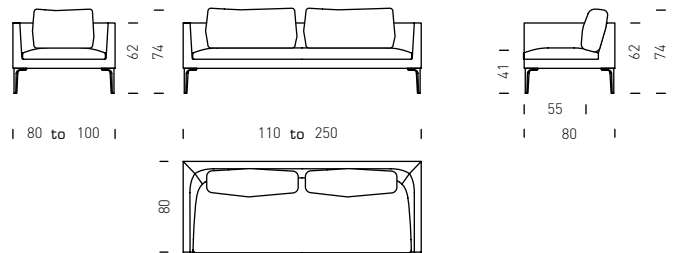

Cover in fabric or leather  
Fabric removable

The length of the furniture can be customized from 70/80 up to 250 cm.  
Back cushions are customized by the length of the furniture and number of seats.

The integrated slatted frame and high quality upholstery of the furniture guarantee optimum comfort.

Stable frame construction in solid wood, plywood and steel profiles.

Foam padding in various degrees, back cushion in down.

Legs in polished aluminium, matt finish white matt, black matt or RAL colored.

For customized dimensions, solutions or an adjustment of seating comfort please contact us.

Softshell M + XL



## Softshell M + XL



## Softshell XL



## Softshell XL



## Softshell M



## Softshell XL



## Softshell XL



## Softshell M



## Softshell

Bi-Color  
bi-couleur  
bi-colour



## Softshell

Bi-Color  
bi-couleur  
bi-colour



# Softshell

Sofa Sessel  
Sofa Fauteuil  
Sofa Armchair

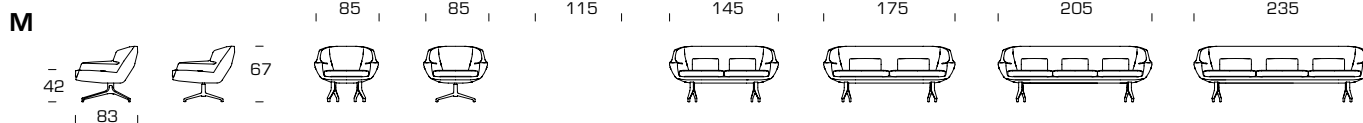

Ohren-Sofa    Ohren-Sessel  
Sofa à oreilles    fauteuil à oreilles  
Wing sofa    wing chair

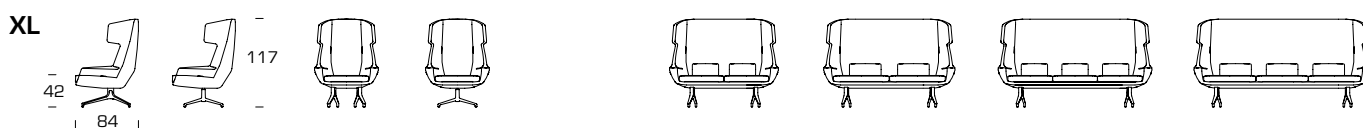

Hocker    Bank    Liege  
Tabourette    Banc    Daybed  
Stool    Bench    Daybed

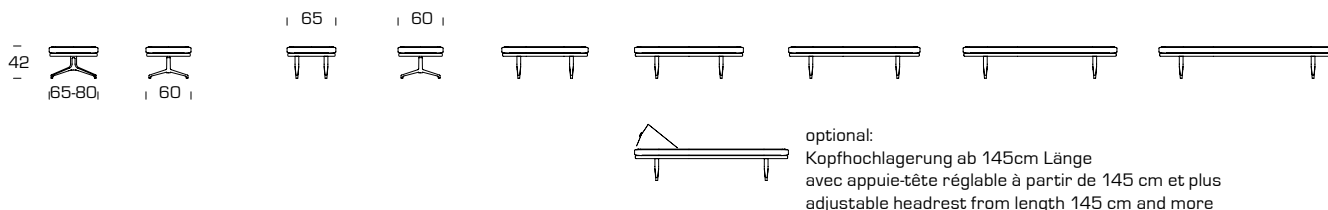

Bezug in Stoff oder Leder  
auch in Bi-Color

Ein integrierter, ultraflacher Federleisten-Rost ermöglicht eine sehr komfortable Sitz- und Liegequalität. Die Länge vom Möbel kann nach Mass produziert werden von 85 bis ca. 250 cm, ab 250 cm zweiteilig.

Stabile Rahmenkonstruktion aus Massivholz, Sperrholz, Stahl- und Aluminium-Profilen. Polsteraufbau aus verschiedenen Schaumstoffen.

Kreuzfuss und Gabelfuss aus Aluminium-Guss, Kufen aus CNS Rundstahl. Oberflächen: poliert, matt, schwarz matt sowie pulverbeschichtet nach RAL.

Kein Sitz ist ideal für alle. Wir passen das Möbel und die Sitzqualität gerne Ihren Bedürfnissen an: Abmessungen, Sitzhöhe, Sitztiefe, Härtegrad usw. Für weitere Anpassungen kontaktieren Sie uns bitte.

Revêtement en tissu ou cuir  
aussi en bi-couleur

Un sommier à lattes ultraflat permet un grand confort, en position assise ou allongée. La longueur du meuble est disponible sur mesure de 90 à 250 cm. A partir de 250 cm en deux pièces.

Une construction à cadre stable en bois massif, bois contreplaqué avec profils en acier et aluminium. Rembourrage en mousses de différentes densités,

Pied croisé et pied en forme de fourchette en aluminium moulé. Pied traîneau en barres rondes acier inoxydable. Finition brillant, mat, noir mat ou RAL laqué.

Aucune siège est idéale pour tout le monde. Nous adaptons volontiers le meuble comme le confort d'assise à vos besoins: dimensions, hauteur, profondeur, la fermeté du siège ... Veuillez nous contacter pour d'autres solutions individuelles.

Cover in fabric or leather  
also in bi-colour

The integrated ultra-flat slatted frame and high quality upholstery of the furniture guarantee optimum comfort. The length of the furniture can be customized from 90 up to 250 cm. From length 250 cm in two parts.

Stable frame construction in solid wood, plywood, steel and aluminium profiles. Foam padding in various degrees,

Star an fork base made of die-cast aluminium, runners in round bars of stainless steel. Finishes: polished, matt, black matt or RAL colored.

No seat is perfect for everyone. We are pleased to customize the furniture and seating quality to your specific requirements: dimensions, seat depth and height, seat firmness and so on. For other customized solutions, please contact us.

## Lenao



# Lenao



# Lenao



## Lenao



# Lenao



# Lenao

Das Programm Lenao überzeugt durch seine klassische, leichte Linie verbunden mit hohem Sitz- und Liege-Komfort. Ein vielseitiges Möbelprogramm

Sofa Ecksofa Sitzgruppe Sessel Daybed Bank Hocker Beistell-Salontisch

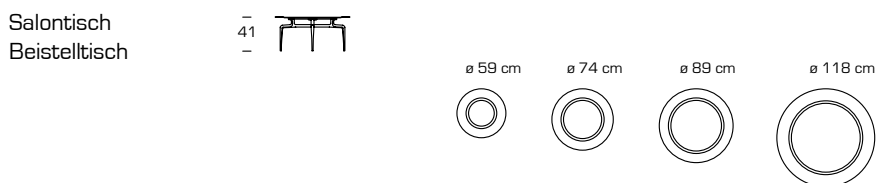
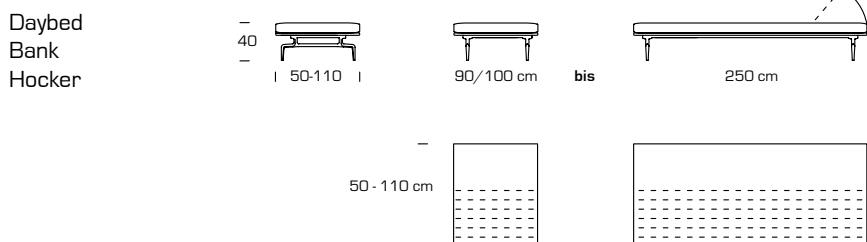
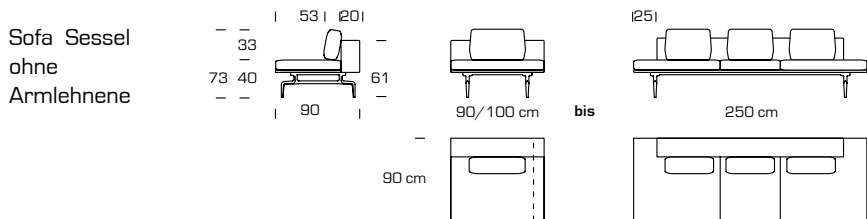
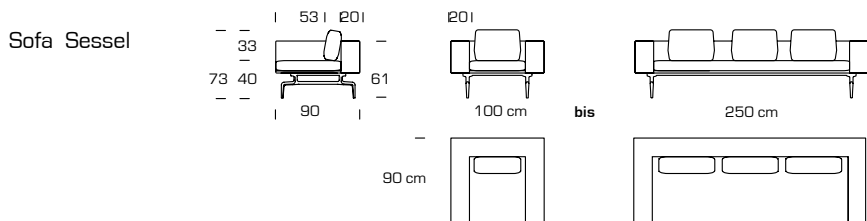

Bezug in Stoff oder Leder  
Stoffbezüge abnehmbar

Ein integrierter, ultraflacher Federleisten-Rost ermöglicht eine sehr komfortable Sitz- und Liegequalität. Die Länge vom Möbel kann nach Mass produziert werden von 90 bis 250 cm. Rückenkissen werden der Länge vom Sofa oder nach Anzahl Sitzplätzen angepasst.

Stabile Rahmenkonstruktion aus Massivholz, Sperrholz, Stahl- und Aluminium-Profilen.  
Polsteraufbau aus verschiedenen Schaumstoffen, Rückenkissen aus Daunen.  
Tischblatt Linoleum und Mehrschicht-Trägerplatte. Linoleum in 20 verschiedenen Farbtönen.

Füße aus Aluminium-Guss poliert, matt, schwarz matt sowie pulverbeschichtet nach RAL.

Für weitere Ausführungen und Abmessungen kontaktieren Sie uns bitte.

# Lenao

La serie Lenao impressionne avec sa ligne claire et classique ainsi que son grand confort, en position assise ou allongée.

Sofa Élément d'angle Fauteuil Daybed Banc Tabouret Table basse Table d'appoint

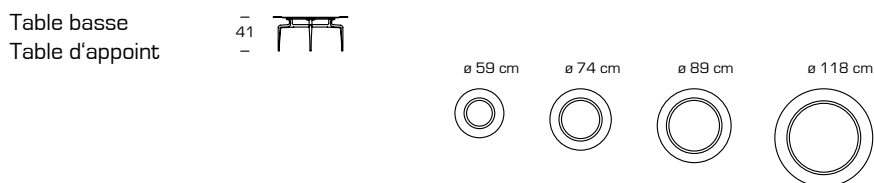
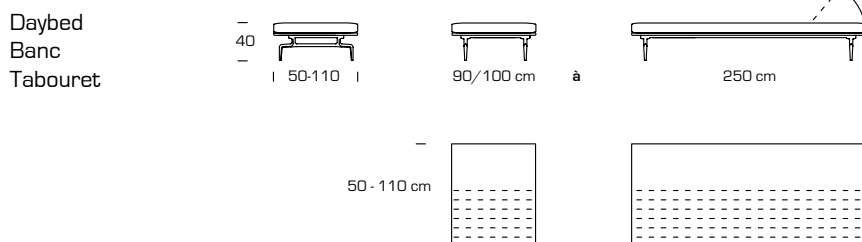
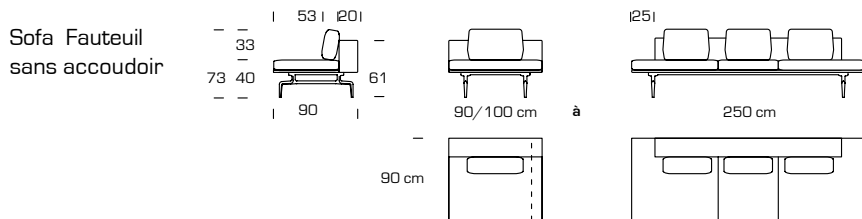
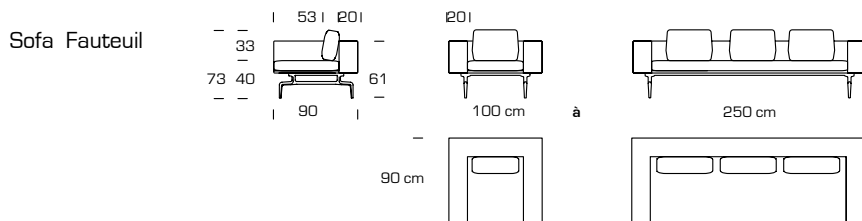

optionnel avec appuie-tête réglable à partir de 150 cm et plus

Revêtement en tissu ou cuir  
Tissu déhoussable

Un sommier à lattes ultraplats permet un grand confort, en position assise ou allongée. La longueur du meuble est disponible sur mesure de 90 à 250 cm. Les coussins de dos sont adaptés à la longueur du meuble ou au nombre de sièges.

Une construction à cadre stable en bois massif, bois contreplaqué avec profils en acier et aluminium. Rembourrage en mousses de différentes densités, Coussin de dos en plumes.

Plateau de table en linoleum contreplaqué avec panneaux multicouches  
Dans 20 couleurs différentes.

Pieds en aluminium brillant, alu mat, noir mat, ou RAL laqué.

Veuillez nous contacter pour d'autres dimensions ou des solutions individuelles.

# Lenao

The series Lenao impresses with its classic, clear lines, high seating and reclining comfort.

Sofa CornerElement Armchair Daybed Bench Stool CoffeeTable SideTable

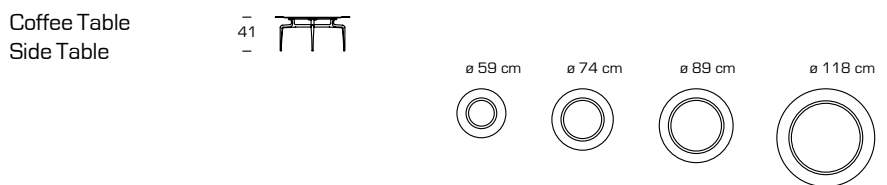
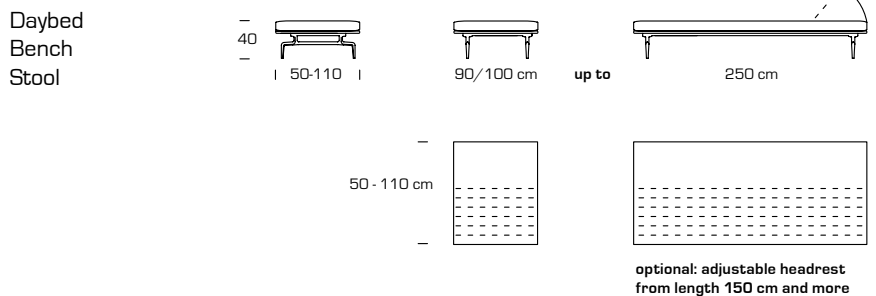
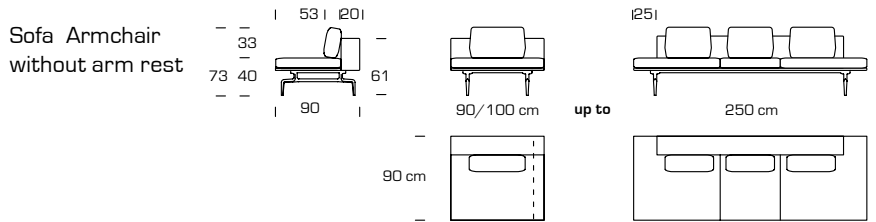
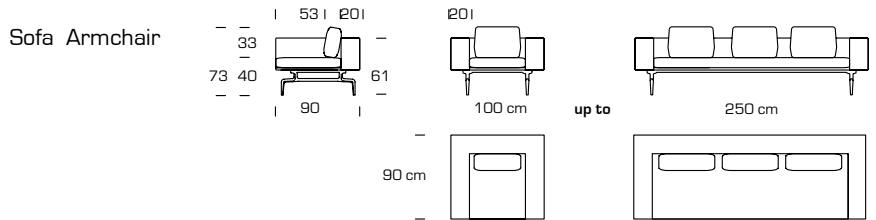

Cover in fabric or leather  
Fabric removable

The integrated ultra-flat slatted frame and high quality upholstery of the furniture guarantee optimum comfort. The length of the furniture can be customized from 90 up to 250 cm. Back cushions are customized by the length of the furniture or number of seats.

Stable frame construction in solid wood, plywood, steel and aluminium profiles.

Foam padding in various degrees, back cushion in down.

Tabletop linoleum with multi-layer board. In 20 different colours.

Legs in polished aluminium, matt finish black matt or RAL colored.

For customized dimensions or solutions, please contact us.

# Lof



Lof



Lof



Lof



# Lof



Sitz fix gepolstert  
Rückenlehne 21 cm

siège rembourré fixe  
dossier 21 cm

seat fix upholstered  
backrest 21 cm



Sitz fix gepolstert  
Rückenlehne 15 cm  
mit Rückenkissen

siège rembourré fixe  
dossier 15 cm  
avec coussin de dos

seat fix upholstered  
backrest 15 cm  
with back cushion



mit Sitzkissen  
Rückenlehne 14 cm  
mit Rückenkissen

avec coussin de siège  
dossier 15 cm  
avec coussin de dos

with seat cushion  
backrest 15 cm  
with back cushion



# Lof

Das Chamäleon unter den Sitz- und Liegemöbeln.

Entscheiden Sie zwischen 2 Sitzqualitäten und wählen Grösse sowie Position von Arm- und Rückenlehnen. Die eine Sitzqualität ist flacher und fix gepolstert mit einer leicht festeren Sitzqualität. Die zweite Variante mit losem Sitzkissen ist weicher. Die Rücken- und Armlehnen sind in Stärke 15 oder 21 cm erhältlich.



Sofa Ecksofa Sitzgruppe Sessel Daybed Bank Hocker

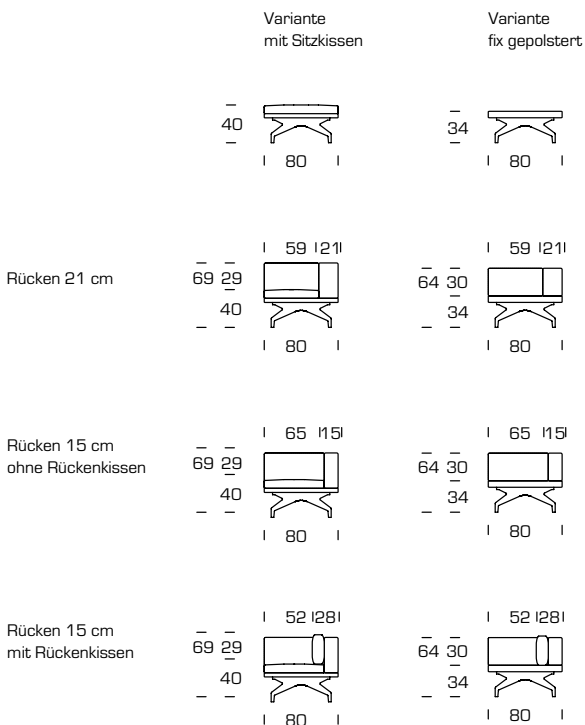

Modell 1  
Hocker Bank Daybed

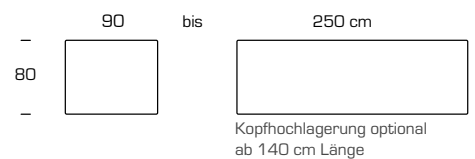

Modell 2  
Sofa Chaiselongue Daybed  
Rücken verkürzt

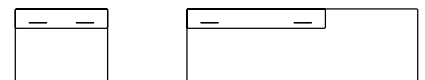

Modell 3  
Sessel Sofa  
Rücken durchgehend

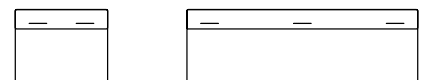

Modell 4  
Chaiselongue Daybed Eckelement  
Rücken verkürzt 1 Armlehne

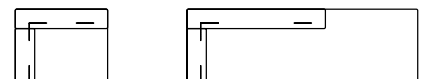

Modell 5  
Sessel Sofa Eckelement  
Rücken durchgehend 1 Armlehne

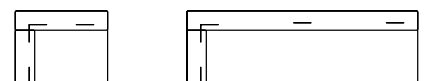

Modell 6  
Sessel Sofa  
Rücken durchgehend 2 Armlehnen

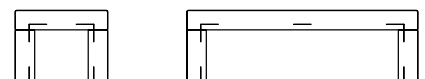

Masse in cm

Bezug in Stoff oder Leder  
Stoffbezüge abnehmbar

Der integrierte, ultraflache Federleisten-Rost bietet eine sehr komfortable Sitz- und Liegequalität. Die Möbellänge kann auf Mass produziert werden von 90 bis 250 cm. Rückenkissen (optional) werden der Länge vom Sofa oder nach Anzahl Sitzplätzen angepasst.

Stabile Rahmenkonstruktion aus Massivholz, Sperrholz, Stahl- und Aluminium-Profilen. Polsteraufbau aus verschiedenen Schaumstoffen, Rückenkissen Daunen.

Füsse Chromstahl matt, oder matt pulverbeschichtet nach RAL.

Für andere Ausführungen und Abmessungen kontaktieren Sie uns bitte.

# Lof

Le caméléon parmi les sofas et chaises longues.

Choisissez entre deux sièges différents et placez les dossiers et accoudoirs selon vos besoins.

La variante sans coussin de siège est plus basse et un peu plus ferme.

La variante avec coussin est plus souple. Dossier et accoudoirs en épaisseur 15 ou 21 cm.



Sofa Élément d'angle Fauteuil Daybed Chaise Longue Banc Tabouret

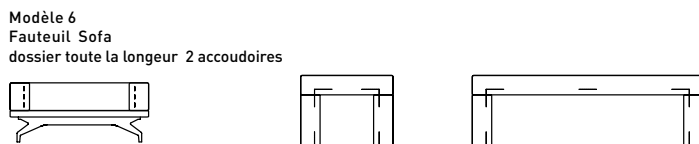
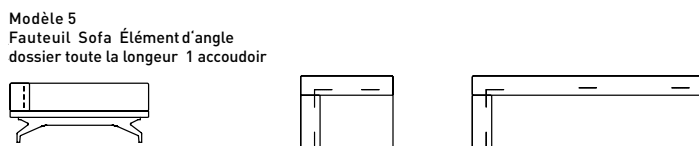
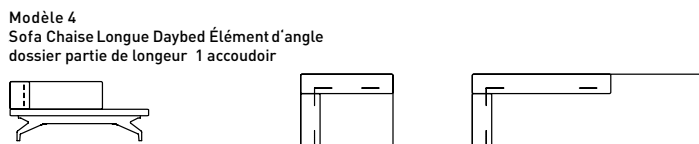
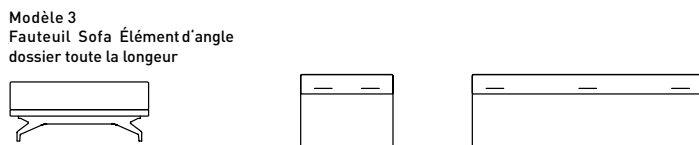
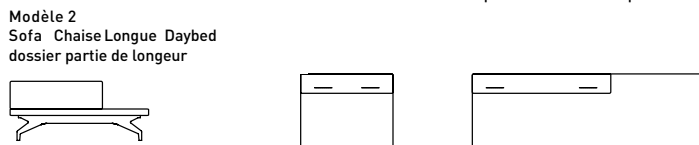
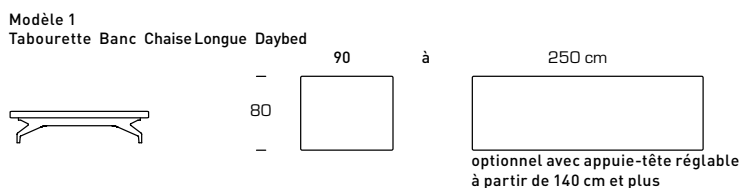
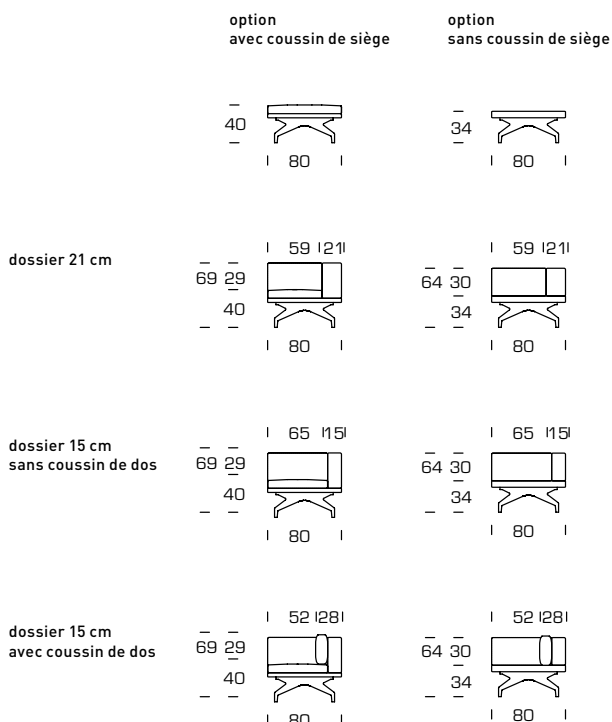

en centimètres

Revêtement en tissu ou cuir  
Tissu déhoussable

Un sommier à lattes ultraplats permet un grand confort, en position assise ou allongée. La longueur du meuble est disponible sur mesure de 90 à 250 cm. Les coussins de dos sont adaptés à la longueur du meuble ou au nombre de sièges.

Une construction à cadre stable en bois massif, bois contreplaqué, profils en acier et aluminium. Rembourrage en mousses de différentes densités, coussin de dos en plumes.

Pieds en acier inoxydable mat, ou RAL laqué mat.

Veillez nous contacter pour d'autres dimensions ou des solutions individuelles.

# Lof

The chameleon amongst seating and lounging furniture.

Select between two different seat variations and choose size and placement of back and armrests.

One seat variation is lower in seating height with a little firmer seating comfort. The variation made with a seat cushion allows a softer comfort. Back and armrests in thickness 15 or 21 cm.



Sofa Corner Element Armchair Daybed Chaise Longue Bench Stool

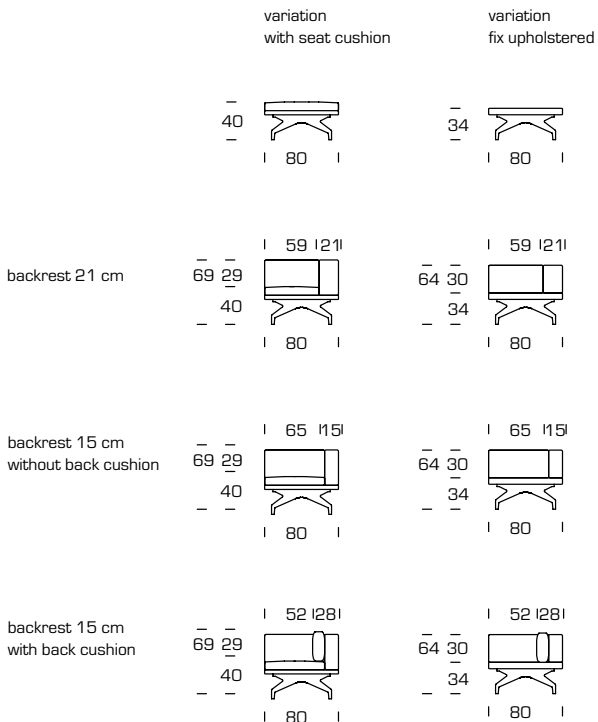

Cover in fabric or leather  
Fabric removable

The integrated ultra-flat slatted frame and high quality upholstery of the furniture guarantee optimum comfort. The length of the furniture can be customized from 90 up to 250 cm. Back cushions (optional) are customized by the length of the furniture or number of seats.

Stable frame construction in solid wood, plywood, steel and aluminium profiles. Foam padding in various degrees, back cushion in down.

Legs in chrome steel matt finish, black matt or RAL colored.

For customized dimensions or solutions, please contact us.

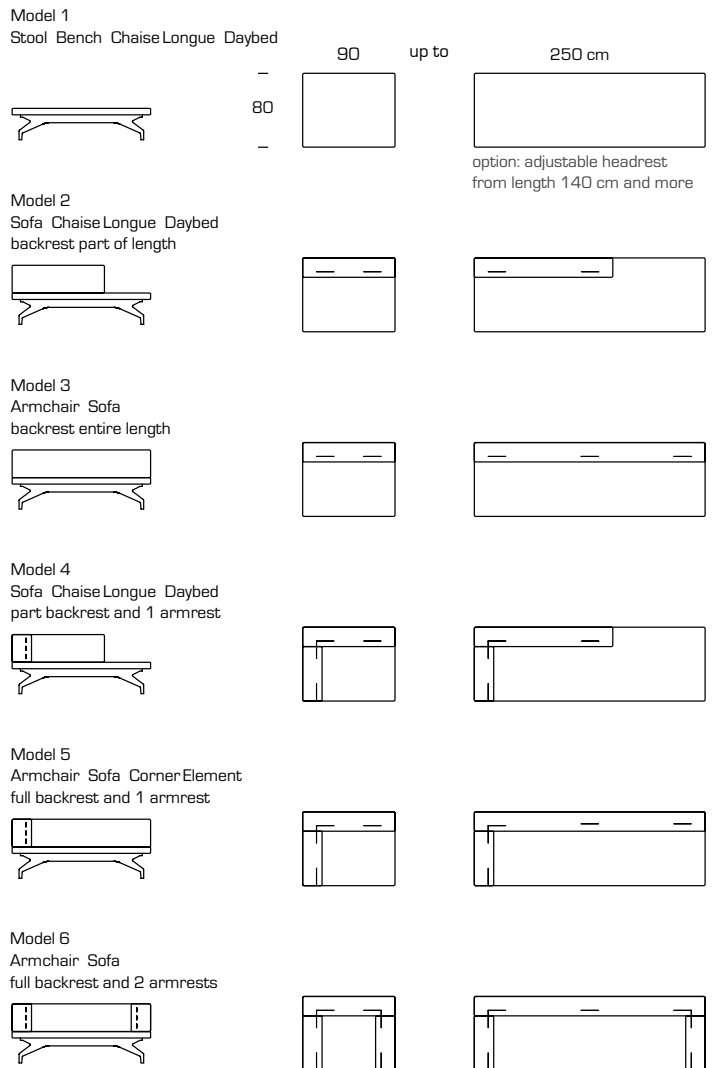

option: adjustable headrest  
from length 140 cm and more

in centimetres

# Slim



## Slim



## Slim



**Slim**



# Slim



Slim Lounge



Slim Living



# Slim

## Das Antisofa.

Kompromisslos, minimal und konzentriert auf das Wesentliche. Durch flexible Anpassung der Länge und der Option der Liegeverlängerung fügt es sich auch in kleine Räume perfekt ein ohne aufzutragen. In zwei Sitzqualitäten erhältlich sowie in der Ausführung mit oder ohne Liegeverlängerung, optional links oder rechts. Die Längen werden nach Mass produziert, vom Sessel 60 cm bis zum Sofa von 220 cm Länge.

Sofa Sessel Chaiselongue Bank

### Slim Lounge

absolut, schlicht, klar  
fix gepolstert, festere Sitzqualität

mit Liegeverlängerung

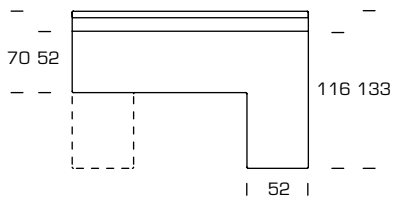
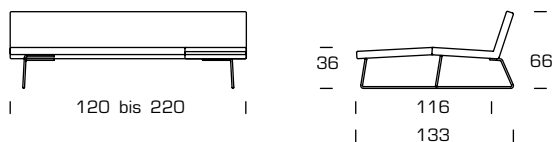

### Slim Living

mit Auflage-Kissen  
komfortablere, weichere Sitzqualität

mit Liegeverlängerung

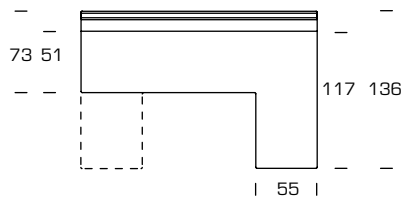
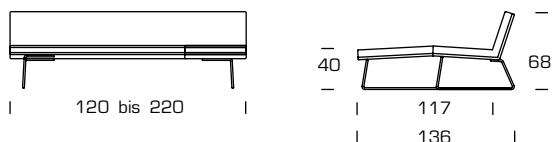

### Lounge ohne Liegeverlängerung

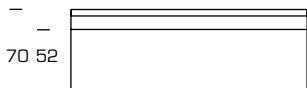
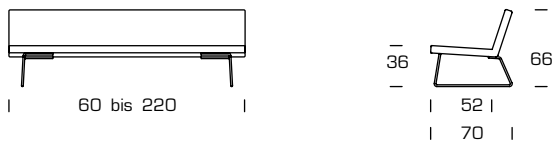

### Living ohne Liegeverlängerung

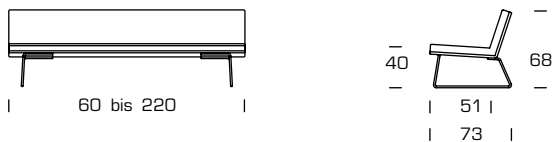

Masse in cm

Bezug in Stoff oder Leder  
Stoffbezüge bei 'Living' abnehmbar

Formstabile Konstruktion aus Stahl-Profilen und Sperrholz Polsteraufbau mit diversen Schaumstoffen.

Kufen Chromstahl mattiert oder schwarz matt oder pulverbeschichtet nach RAL.

Für andere Ausführungen und Abmessungen kontaktieren Sie uns bitte.

# Slim

L'antisofa.

Sans compromis, minimal et concentré sur l'essentiel.

Repose-jambes optionnel, à gauche ou à droite. En deux variations de sièges,

La longueur est disponible sur mesure de 60 à 220 cm.

Sofa Fauteuil Chaise Longue Banc

## Slim Lounge

une ligne absolument pure  
un confort plus ferme

avec repose-jambes

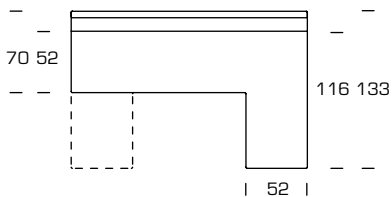
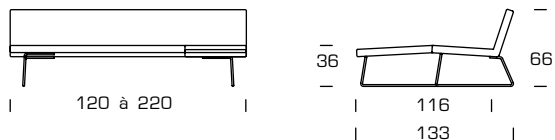

sans repose-jambes

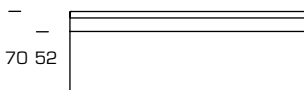
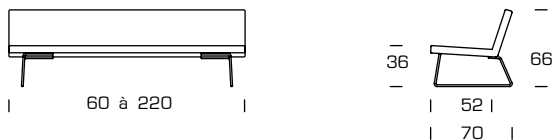

## Slim Living

avec coussin de siège et coussin de dos  
un confort plus souple

avec repose-jambes

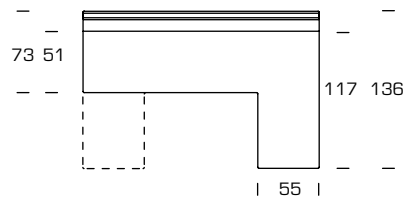
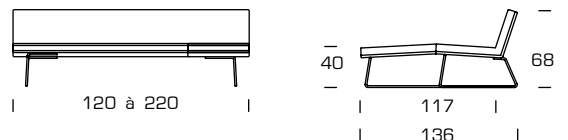

sans repose-jambes

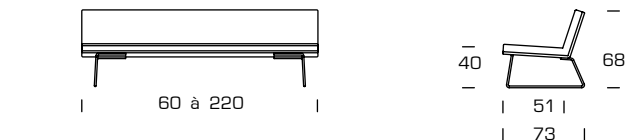

en centimètres

Revêtement en tissu ou cuir

Tissu 'Living' déhoussable

Construction stable en bois contreplaqué avec profils en acier. Rembourrage en mousses de différentes densités,

Pieds en acier inoxydable mat, noir mat ou RAL laqué.

Veuillez nous contacter pour d'autres dimensions ou des solutions individuelles.

# Slim

The antisofa.  
 Uncompromising, minimal and concentrated on the essential.  
 Optional legrest, left or right. Two different seat variations.  
 The length is customized from 60 up to 220 cm.

Sofa Armchair Chaise Longue Bench

## Slim Lounge

absolutely clear line  
 a firmer seating comfort

with legrest

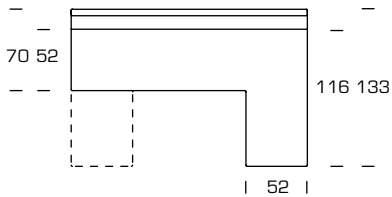
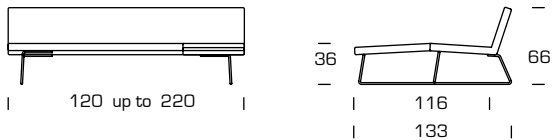

without legrest

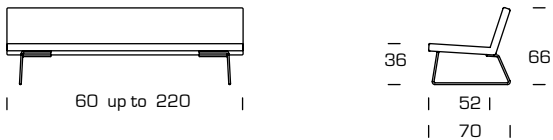

## Slim Living

seat and back cushions  
 a softer seating comfort

with legrest

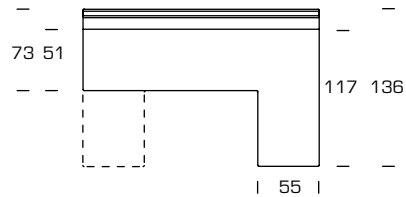
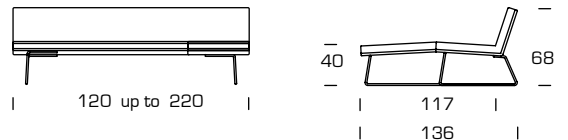

without legrest

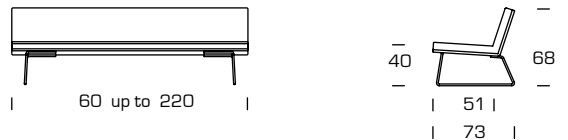

in centimetres

Cover in fabric or leather  
 Fabric covers 'Living' removable

Stable construction in plywood and steel profiles  
 Foam padding in various degrees.

Legs in chrome steel matt finish, black matt or  
 RAL colored.

For additional dimensions or solutions, please  
 contact us.

## 2cube



## 2cube



## 2cube



## 2cube



## 2cube



# 2cube

kubisch gradlinig konsequent

Sofa Sitzgruppe Sessel Chaiselongue Bank Hocker



## Standard-Masse

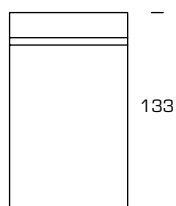
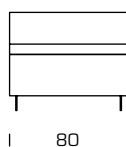
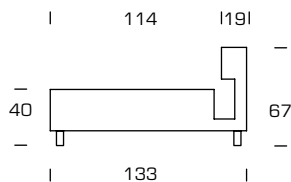
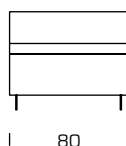
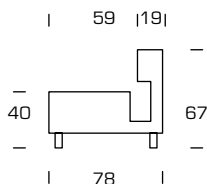
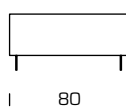
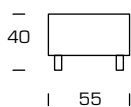

## mögliche Dimensionen

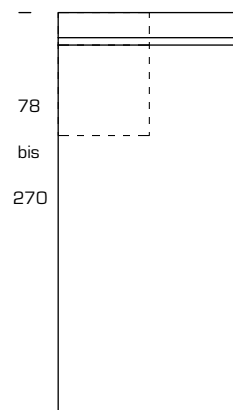
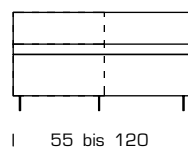
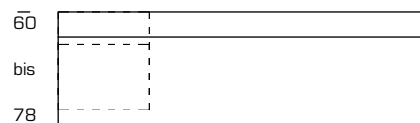
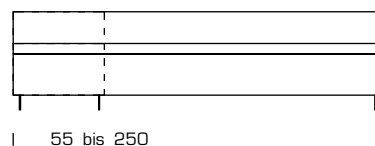
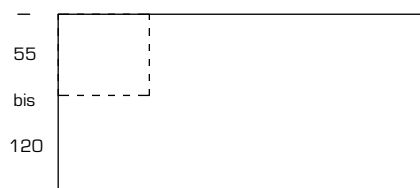
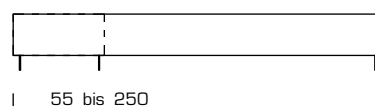

masse in cm

Bezug in Stoff oder Leder  
Stoffbezüge abnehmbar optional

Formstabile Rahmenkonstruktion aus Massivholz, Sperrholz und Stahl-Profilen

Der integrierte, ultraflache Federleisten-Rost bietet eine sehr komfortable Sitz- und Liegequalität. Polster Aufbau aus verschiedenen Schaumstoffen.

In Standard-Massen oder nach Mass gefertigt.

Füsse alu matt, chrom glanz oder pulverbeschichtet nach RAL

Für andere Ausführungen und Abmessungen kontaktieren Sie uns bitte.

# 2cube

cubique rectiligne sans compromis

Sofa Ensemble Fauteuil Chaise Longue Banc Tabouret

### dimensions standards

### dimensions possible

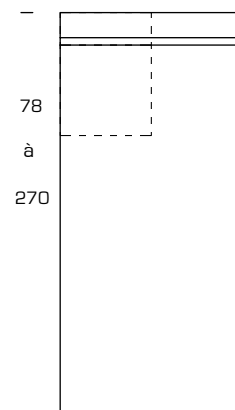
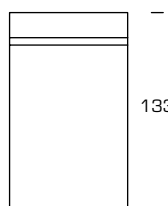
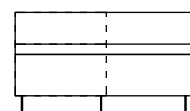
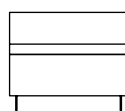
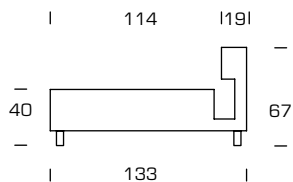
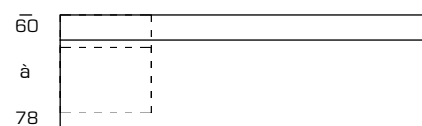
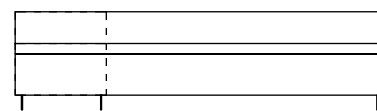
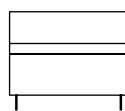
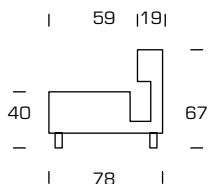
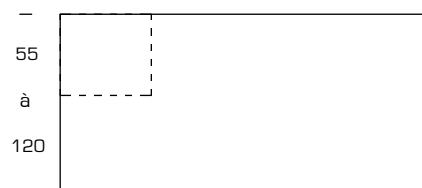
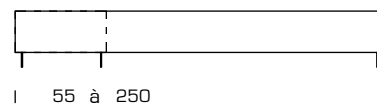
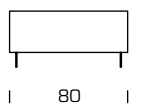

Revêtement en tissu ou cuir  
Revêtement déhoussable sur demande

Une construction stable en bois massif, bois contreplaqué avec profils en acier.

Un sommier à lattes ultraplat permet un confort suprême, en position assise ou allongée. Rembourrage en mousses de différentes densités. Dimensions standards ou sur mesure.

Pieds en aluminium mat, alu brillant, ou RAL laqué.

Veuillez nous contacter pour d'autres dimensions ou des solutions individuelles.

en centimètres

# 2cube

cubic rectilinear consistent

Sofa Armchair Chaise Longue Bench Stool



standard dimensions

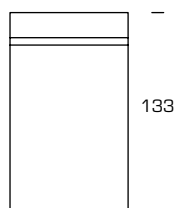
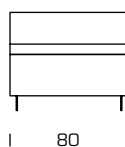
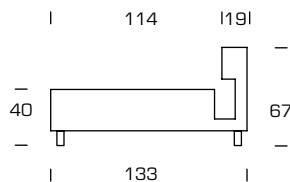
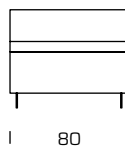
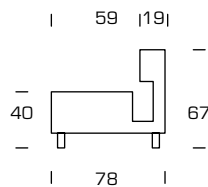
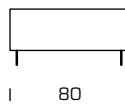
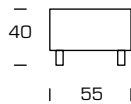

possible dimensions

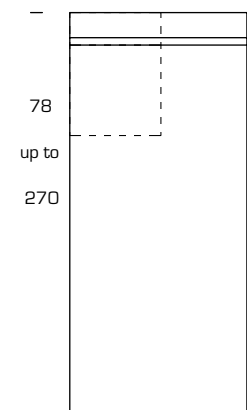
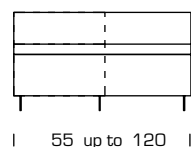
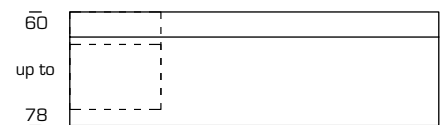
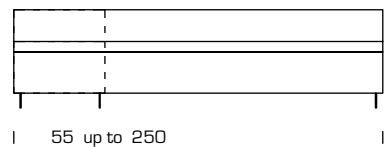
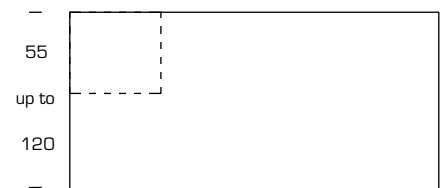
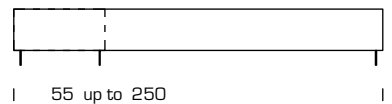

in centimetres

Cover in fabric or leather  
Removable covers optional

The integrated ultra-flat slatted frame and high quality upholstery of the furniture guarantee optimum comfort. In standard or customized dimensions.

Stable frame construction in solid wood, plywood and steel profiles.

Foam padding in various degrees.

Legs in aluminium matt, brilliant chrome or RAL colored.

For customized dimensions or solutions, please contact us.

**Lenao Bett**



**Lenao** Bett



**Lenao** Bett



**Lenao** Bett



**Lenao** Bett



small



high



medium

## Lenao bett

Das Bett LENAÖ ist auf das Wesentliche reduziert, bietet jedoch alles was ein komfortables Bett braucht.

small

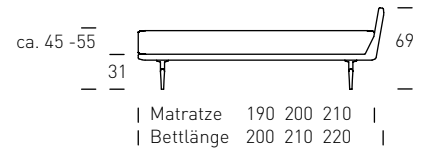
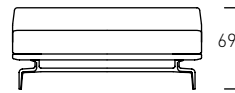

medium

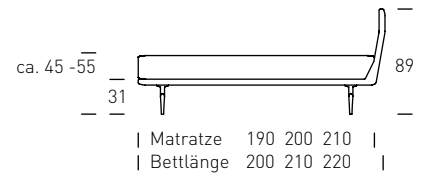
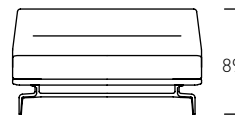

high

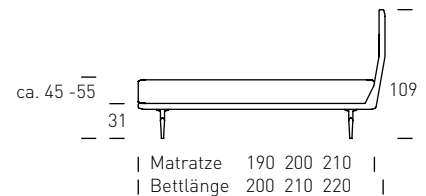
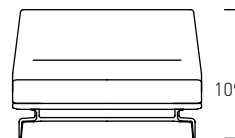

Matratzen-Breite = Bettbreite  
90 100 120 140 160 180 200

Masse in cm

Kopfhaupt in 3 verschiedenen Höhen  
Bezug in Stoff oder Leder  
Stoffbezüge abnehmbar

Der Lattenrost ist integriert  
Latten flexibel gelagert  
Elastische Schulterkomfortzone. Individuell einstellbare Mittelzonenverstärkung. Kopfhochlagerung optional  
Lattenrost ab 140 cm zweiteilig

Stabile Rahmenkonstruktion aus Eiche massiv, Alu-Profilen, Sperrholz, gepolstert.

Füsse Alu-Guss: poliert, matt, schwarz  
matt oder pulverbeschichtet nach RAL

Für andere Ausführungen, Abmessungen und Anpassungen an Spezialmattmatratzen kontaktieren Sie uns bitte.

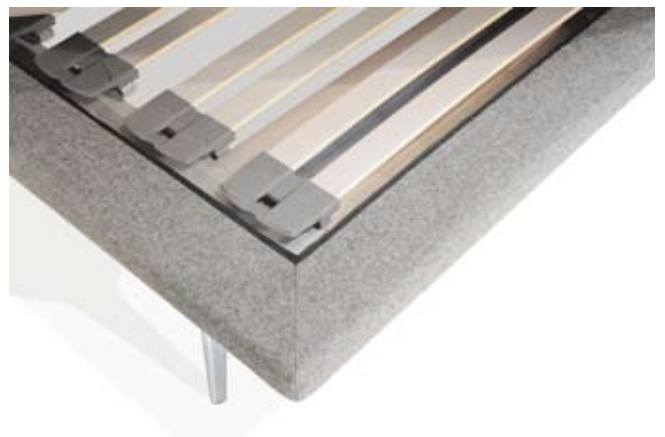

## Lenao bett

Un design léger, en filigrane et concentré sur l'essentiel.  
Lenao offre tout ce qu'un lit d'un grand confort a besoin.

small

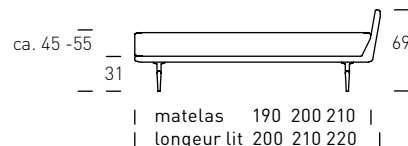
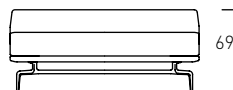

medium

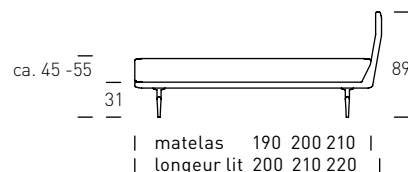
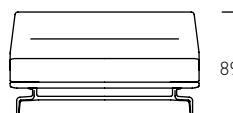

high

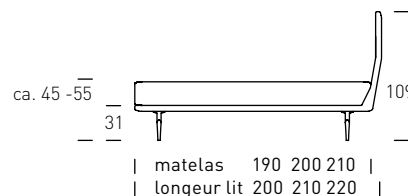
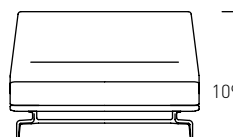

largeur matelas = largeur lit  
90 100 120 140 160 180 200

en centimètres

Tête de lit en 3 différentes hauteurs  
Revêtement en tissu ou cuir  
Tissu déhoussable

Sommier à lattes intégré avec porte-lattes flexible. Zone de confort des épaules élastique. Réglage individuel de la zone médiane. Partie tête réglable optionnelle. Deux sommiers à partir de 140 cm.

Une construction stable en bois massif et bois contreplaqué, profils en aluminium.

Pieds en aluminium brillant, alu mat, noir mat, ou RAL laqué.

Veillez nous contacter pour d'autres dimensions ou des solutions individuelles.

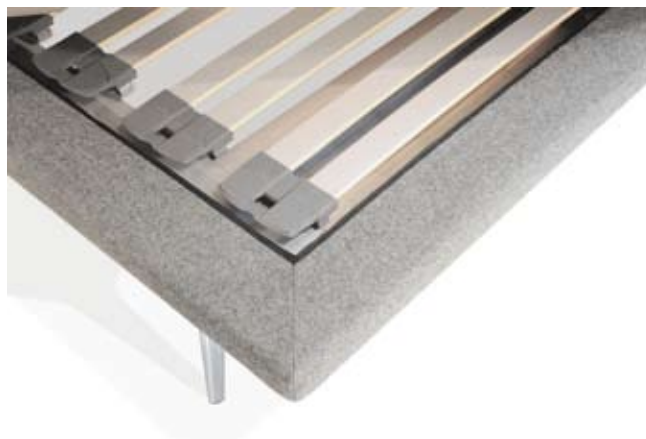

## Lenao bett

Its light design is concentrated on the essential and offers everything a bed needs for optimum comfort.

small

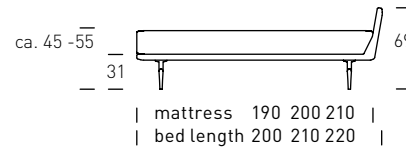
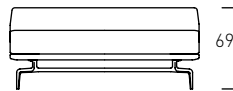

medium

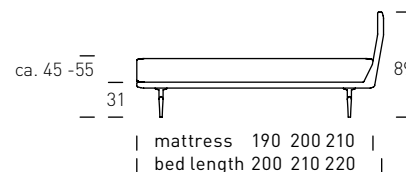
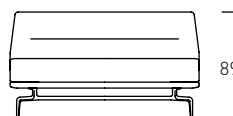

high

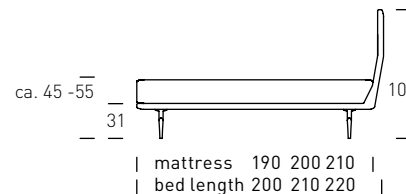
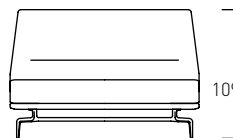

width mattress = width bed  
90 100 120 140 160 180 200

in centimetres

Headboard height in 3 dimensions

Cover in fabric or leather

Fabric removable

Integrated slatted frame

Flexible supported slats

Middle zone firmness adjustable

Adjustable head zone optional

From 140 cm two slatted frames

Stable frame construction in solid wood, plywood, aluminium profiles, foam padding in various degrees.

Legs in aluminium polished, matt finish, black matt or RAL colored.

For customized dimensions or solutions for special mattresses, please contact us.

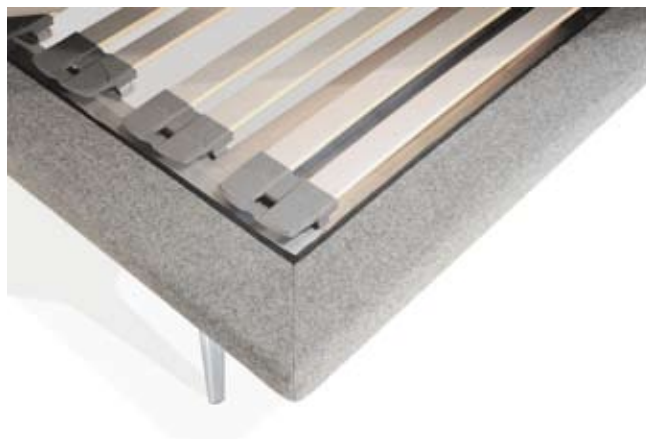

**SP** sleeping pure



**SP** sleeping pure



**SP** sleeping pure



## SP sleeping pure

beinah schwerelos  
für unbeschwertes Schlafen  
Die Füße sind bis zirka 3 Meter Distanz nicht sichtbar.

### allseitig Rahmen

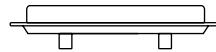

ca. 35-45  
— 23



| Matratze 190 200 210 |  
| Bettlänge 215 225 235 |

Matratze 140  
Bettbreite 165

Matratze 160  
Bettbreite 185

Matratze 180  
Bettbreite 205

Matratze 200  
Bettbreite 225

### mit Kopfhaupt



ca. 35-45  
— 23

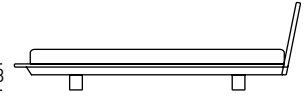

| Matratze 190 200 210 |  
| Bettlänge 217 227 237 |

Masse in cm

Ausführung in 2 Grundvarianten  
allseitig Rahmen oder mit Kopfhaupt

Bezug in Stoff oder Leder  
Stoffbezüge abnehmbar

Stabile Rahmenkonstruktion aus  
Alu-Profilen, Sperrholz, gepolstert  
Füße Holz, Stahl schwarz

Bett ohne Lattenrost  
Lattenroste solle nicht höher als 7.5cm sein.  
Die Anpassung an höheren Lattenrost ist  
möglich. Wir führen geeignete Lattenroste im  
Sortiment.

Die Höhe vom Kopfhaupt kann auf Mass ge-  
fertigt werden. Für andere Ausführungen,  
Abmessungen und Anpassungen an Spezial-  
matratzen kontaktieren Sie uns bitte.

## SP sleeping pure

presque en état d'apesanteur  
pour un sommeil reposant

Les pieds ne sont pas visible jusqu'à une distance d'environ 3 mètres.

### cadre complet

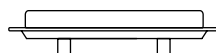

ca. 35-45  
— 23

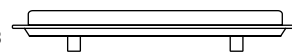

| matelas 190 200 210 |  
| longueur lit 215 225 235 |

matelas 140  
largeur lit 165

matelas 160  
largeur lit 185

matelas 180  
largeur lit 205

matelas 200  
largeur lit 225

### avec tête de lit

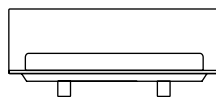

ca. 35-45  
— 23

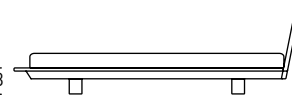

| matelas 190 200 210 |  
| longueur lit 217 227 237 |

—  
78  
—

en centimètres

En 2 variantes

Cadre tout autour ou avec une tête de lit

Revêtement en tissu ou cuir

Tissu déhoussable

Une construction stable en bois contreplaqué  
avec profils en acier et aluminium. Rembour-  
rage en mousses de différentes densités.

Pieds en bois et acier noir.

Le lit est fourni sans sommier. Le sommier  
ne doit pas dépasser une hauteur de 7.5 cm.  
Pour des sommiers plus haut, un ajustement  
est possible. Nous avons des sommiers à  
lattes dans notre programme.

La hauteur de la tête de lit peut être faite  
sur mesure. Veuillez nous contacter pour  
d'autres dimensions ou des solutions pour  
des matelases individuelles.

## SP sleeping pure

almost airborne  
for a relaxing sleep  
The legs are not visible up to a distance of approximately 3 metres.

### all-sided frame

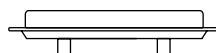

mattress 140  
bed width 165

mattress 160  
bed width 185

mattress 180  
bed width 205

mattress 200  
bed width 225

### with headboard

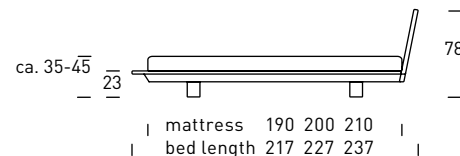
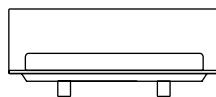

in centimetres

In 2 variations

Frame all around or with a headboard

Cover in fabric or leather

Fabric covers removable

Stable frame construction in plywood, aluminium profiles, foam padding in various degrees  
Legs wood, steel black

Bed without slatted frame

The slatted frame should not be higher than 7.5 cm. Adjustment for higher slatted frames is possible. We have suitable slatted frames available in our product range.

The height of headboard can be customized.  
For customized dimensions or solutions for special mattresses, please contact us.

## Tx-2

Sideboard Schrank Garderobe



## Tx-2

Sideboard



## Tx-2

Sideboard



## Tx-2

Schrank Garderobe



## Tx-2

Schrank Garderobe



## Tx-2

Schrank Garderobe



## Tx-2

### Sideboard Schrank Garderobe



Sideboard Schrank Garderobe

rundum textil - rundum sehenswert

Die Hülle kann in verschiedenen Stoffen in zahlreichen Farben, Strukturen und Mustern konfektioniert werden.  
2, 3, 4, 5 .. und mehr Türen

Der Basisrahmen ist in verschiedenen Holzarten und Oberflächen erhältlich.  
Türrahmen aus Aluminiumprofilen

Die innere Ausstattung mit Fachböden, Kleiderstangen, Schubladen usw. wird nach Ihren Bedürfnissen gefertigt.



Sideboard armoire garde-robe

textile tout autour - remarquable sous tous les angles

La housse peut être confectionnée en divers textiles en nombreuses couleurs, structures ainsi que à motifs.  
2, 3, 4, 5 .. portes et plus

Le cadre de base est disponible en différents bois et surfaces.  
Cadre des portes en profils aluminium

L'aménagement intérieur avec étagères, tringles et tiroirs sera confectionné selon vos besoins et vos désirs.



Sideboard cupboard wardrobe

all-sided textile - all-sided worth seeing

The cover can be produced in different textiles in a wide range of colours, structures and patterns.  
2, 3, 4, 5, ... doors and more

The base frame is available in different wood types and surface finishes.  
Doors in aluminium profiles

The inner furnishing with shelves, clothes rails and drawers will be tailor made according to your needs.

# Tx-2

## Schrank Garderobe

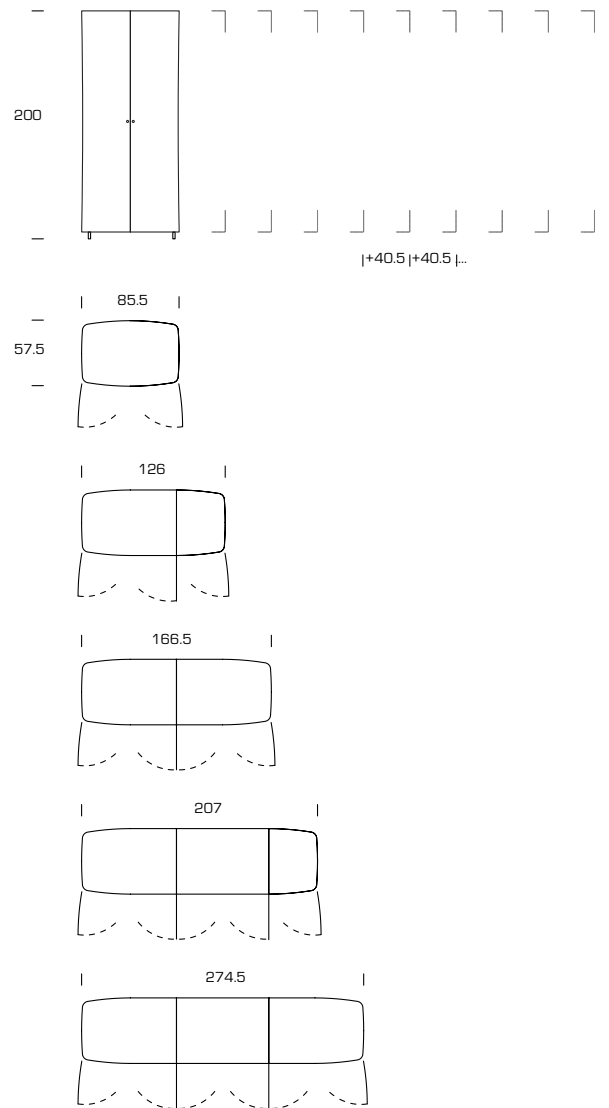

# Tx-2

## Sideboard

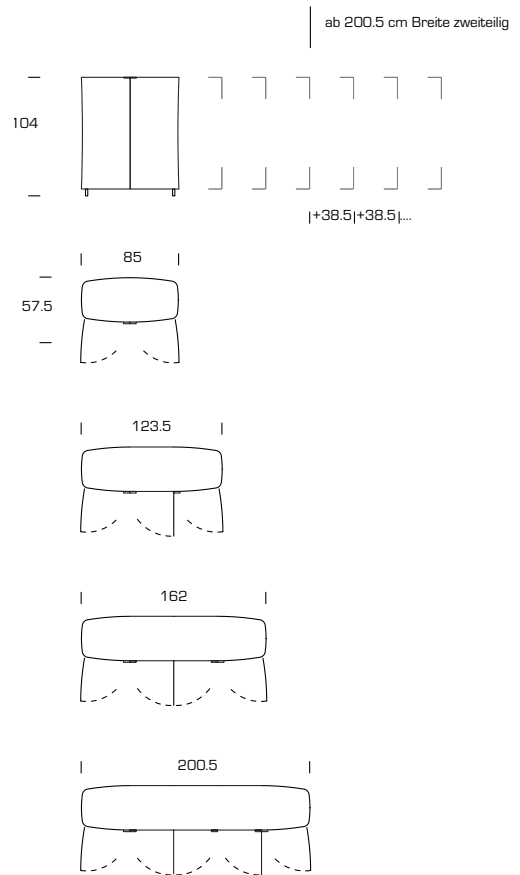

in/en cm

Material und Oberflächen Basisrahmen  
 Matériaux et surfaces du cadre de base  
 Materials and surfaces of the base frame

MDF naturfarben weiss beschichtet  
 MDF couleur naturel mélaminé blanc  
 MDF natural colour white laminated



Birke Multiplex Eiche furniert, weiss geölt  
 Multiplex de bouleau plaqué en chêne, huilé blanc  
 Birch Multiplex oak veneered, oiled white



MDF schwarz weiss beschichtet  
 MDF noir mélaminé blanc  
 MDF black white laminated



Birke Multiplex Eiche furniert, grau geölt  
 Multiplex de bouleau plaqué en chêne, huilé gris  
 Birch Multiplex oak veneered, oiled grey



MDF schwarz grau beschichtet  
 MDF noir mélaminé gris  
 MDF black grey laminated



Birke Multiplex Eiche furniert, geölt nature  
 Multiplex de bouleau plaqué en chêne, huilé nature  
 Birch Multiplex oak veneered, oiled natural



Birke Multiplex furniert Eiche gräucht, grau geölt  
 Multiplex de bouleau plaqué en chêne fumé, huilé gris  
 Birch Multiplex veneered smoked oak, oiled grey



Oberfläche Kunstharz beschichtet in jeder Farbe

Recouvert de résine synthétique disponible dans toutes les couleurs

With synthetic resin coating in all colours



Birke Multiplex furniert Eiche gräucht, geölt nature  
 Multiplex de bouleau plaqué en chêne fumé, huilé nature  
 Birch Multiplex veneered smoked oak, oiled natural

